

Datasheet









HPS15000TL
HPS20000TL

Overview

15-40kW three phase all-in-one hybrid inverter for small and medium industrial and commercial use

Features

-  All-in-one hybrid inverter
-  Seamless on/off grid transfer
-  Compact design
-  Support remote control of DG
-  Touchscreen LCD
-  Programmable working mode

Block Diagram

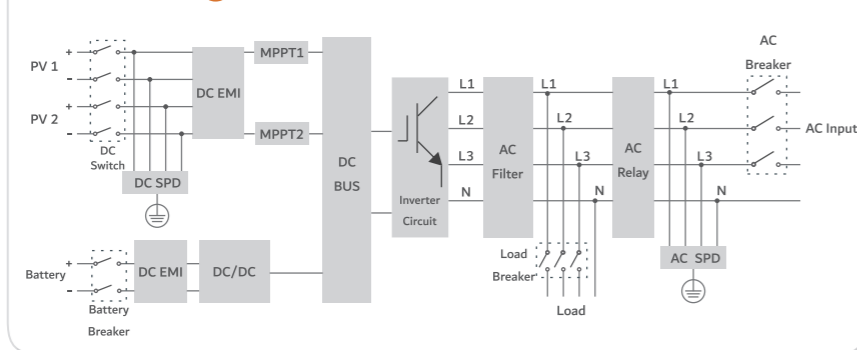

HPS15000TL

HPS20000TL

AC (Grid-connected)

Apparent power	16kVA	22kVA
Rated power	15kW	20kW
Rated voltage	400V	400V
Rated current	21A	28A
Voltage range	360~440V	360~440V
Rated frequency	50/60Hz	50/60Hz
Frequency range	47~51.5/57~61.5Hz	47~51.5/57~61.5Hz
THDI	<3%	<3%
PF	0.8lagging~0.8leading	0.8lagging~0.8leading
AC connection	3/N/PE	3/N/PE

AC (Off-grid)

Apparent power	16kVA	22kVA
Rated power	15kW	20kW
Rated voltage	400V	400V
Rated current	21A	28A
THDU	≤2%linear	≤2%linear
Rated frequency	50/60Hz	50/60Hz
Overload capability	110%-10 mins 120%-1 min	110%-10 mins 120%-1 min

DC (Battery and PV)

Max. PV Open-circuit voltage	1000V	1000V
Recommended PV power	18kWp	24kWp
PV MPPT voltage range	125V-850V	125V-850V
Number of MPPT	2	2
Battery voltage range	260~700V	260~700V
Full load battery voltage range	300~700V	300~700V
Max. charge/discharge power	15kW	20kW
Max. charge/discharge current	50A	66A

General Information

Protection devices	PV DC switch, PV fuse, battery breaker and fuse	PV DC switch, PV fuse, battery breaker and fuse
Protection degree	IP54	IP54
Noise emission	<65dB(A)@1m	<65dB(A)@1m
Operating temperature	-25 °C~+55 °C	-25 °C~+55 °C
Cooling	Forced-air	Forced-air
Relative humidity	0-95% non-condensing	0-95% non-condensing
Maximum altitude	3000m (derate over 2000m)	3000m (derate over 2000m)
Dimension (W/H/D)	450/635/225mm	450/635/225mm
Weight	45kg	45kg
Topology	Transformerless	Transformerless
Lighting protection	Type II	Type II
Transfer between on/off grid	Automatic≤10ms	Automatic≤10ms
Standby consumption	<20W	<20W

Communication

Display	Touch screen	Touch screen
Communication	RS485/CAN	RS485/CAN

Certificate

CE, EN 61000-6-4:2007+A1:2011, EN61000-6-2:2005, EN62109-1:2010, EN62109-2:2011, NRS097-2-1:2017